

This amendment captures the following corrections to the PI-2021-1 report posted on 7/9/2021. The oneline has been corrected to show the correct Point of Change of Ownership (PCO).

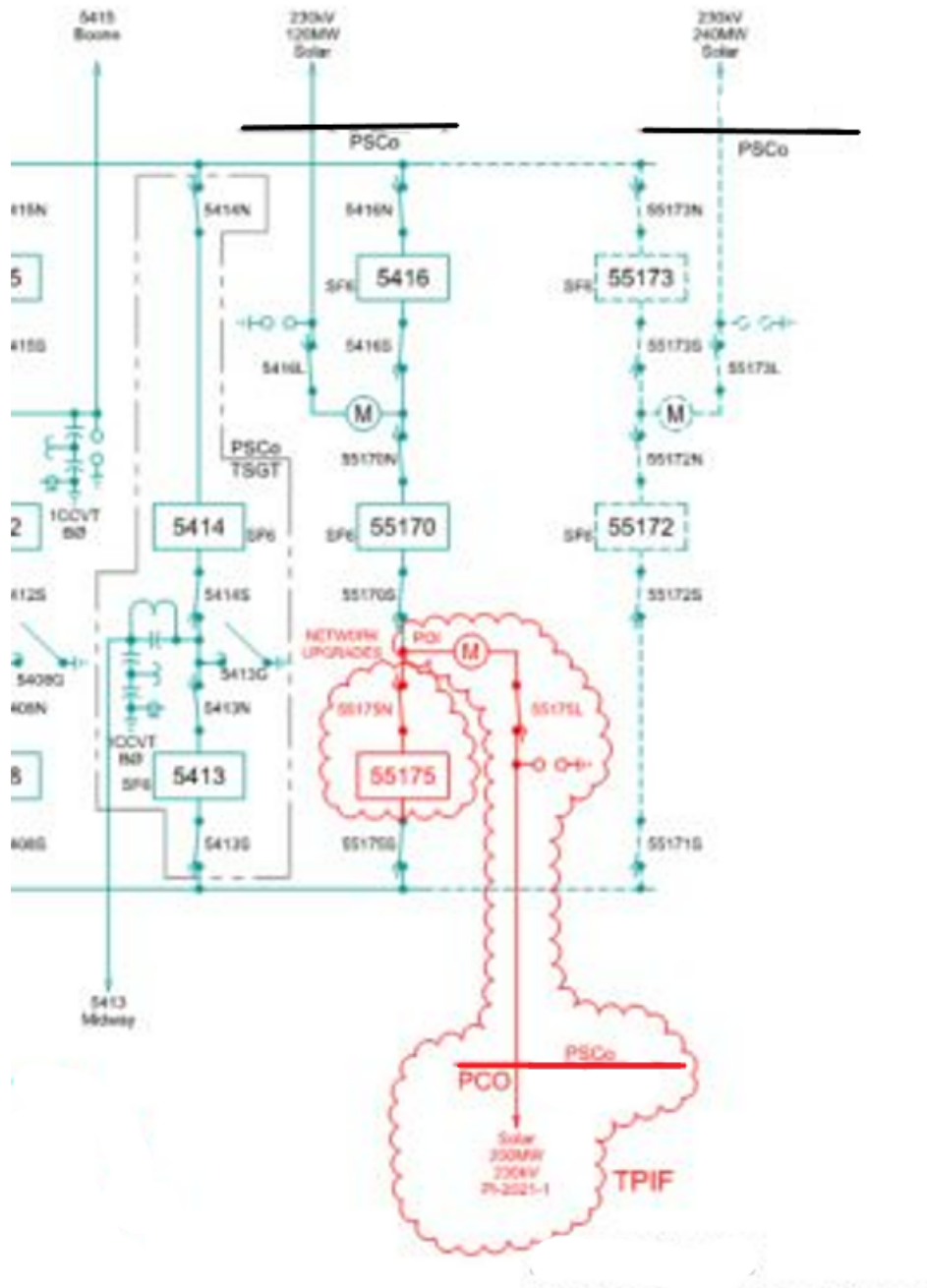

Following are the stability plots missing from the 7/9/2021 report

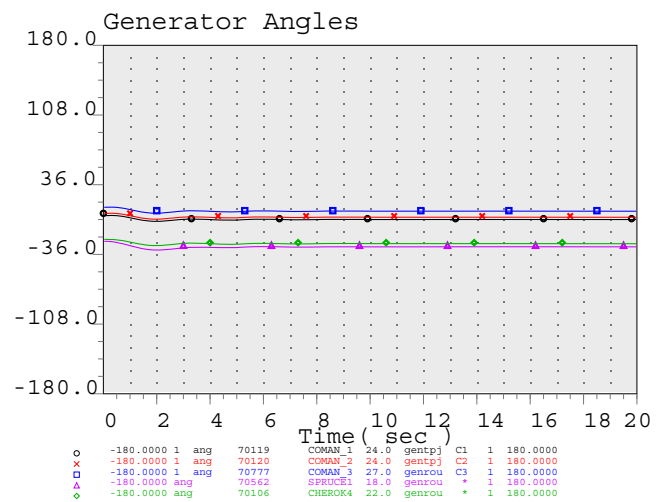
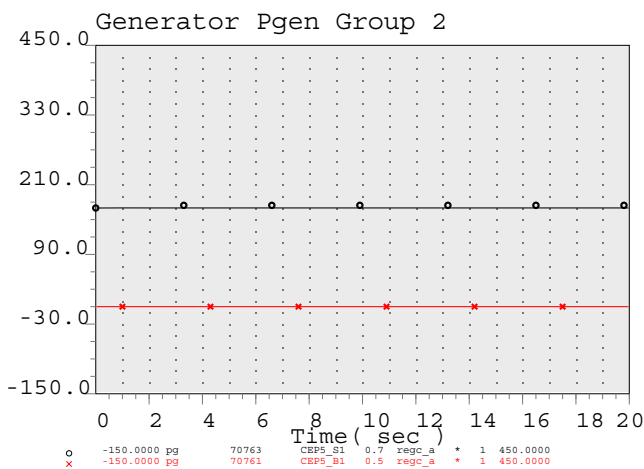
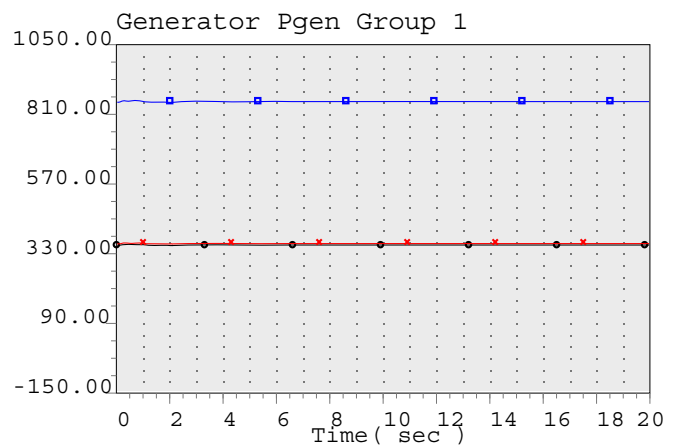
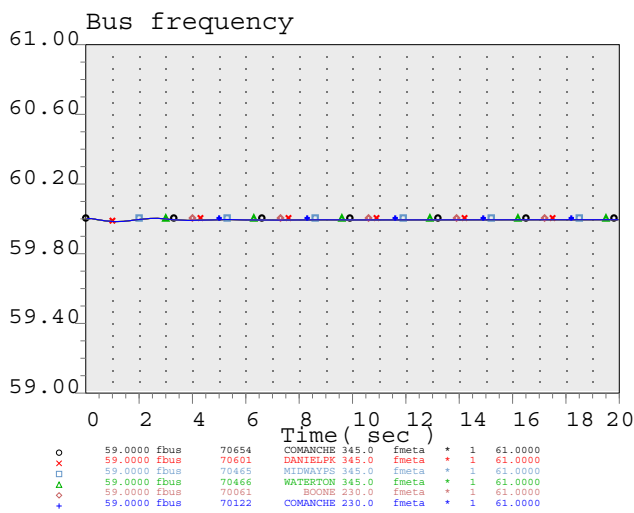
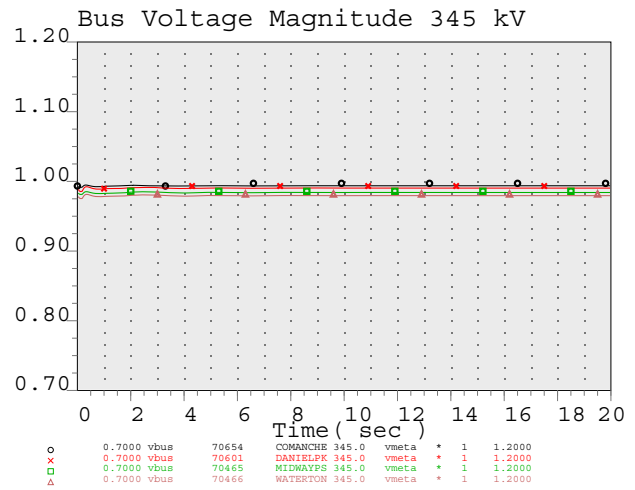
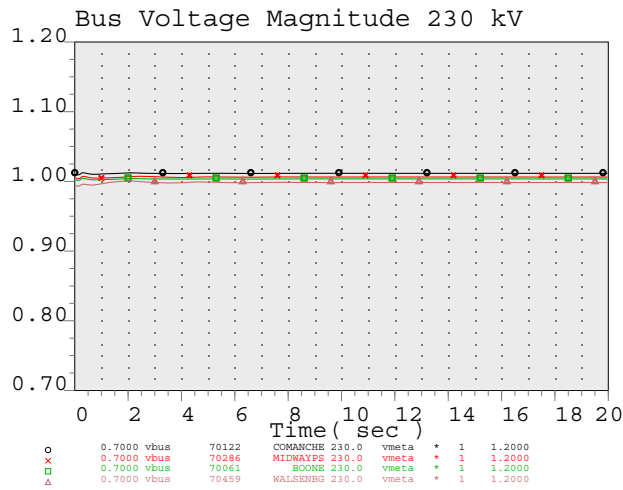

PI-2021-1  
200MW at Comanche 230kV



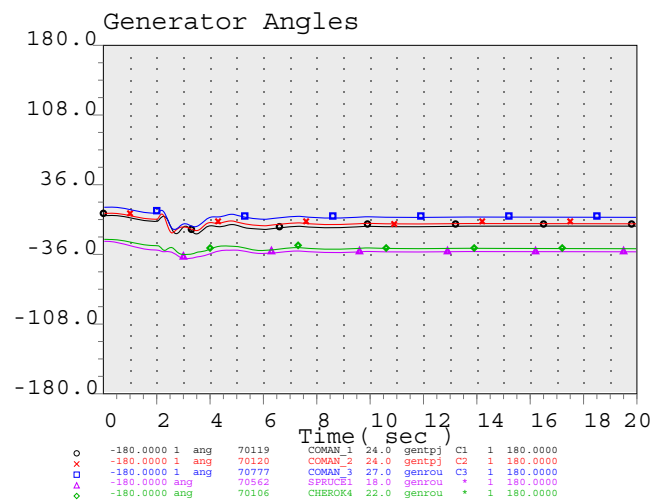
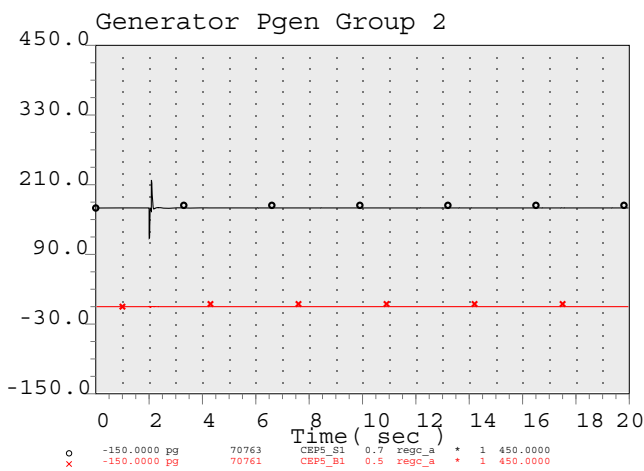
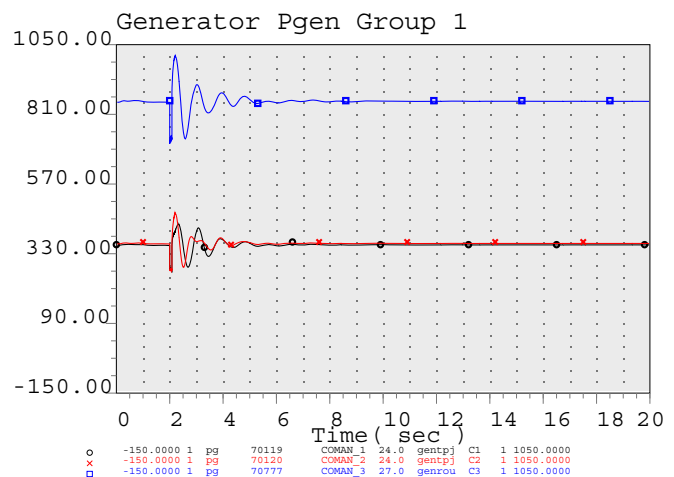
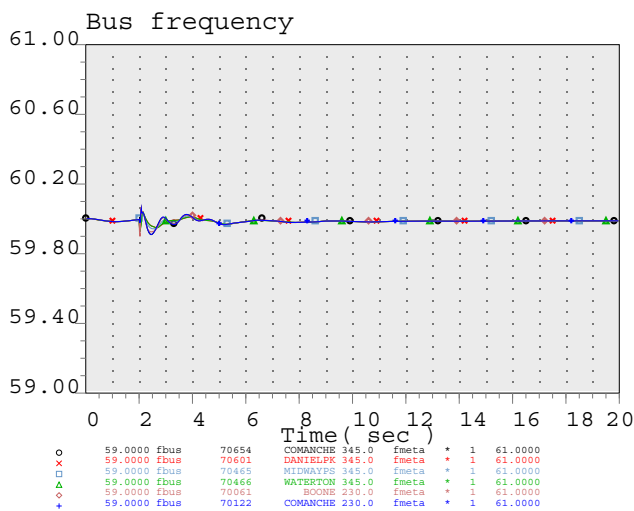
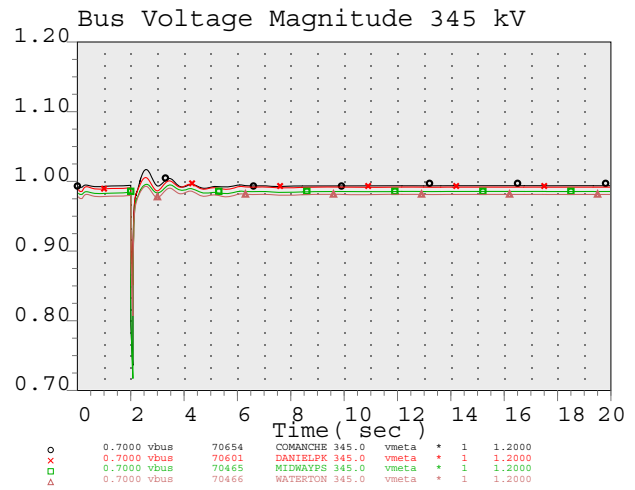
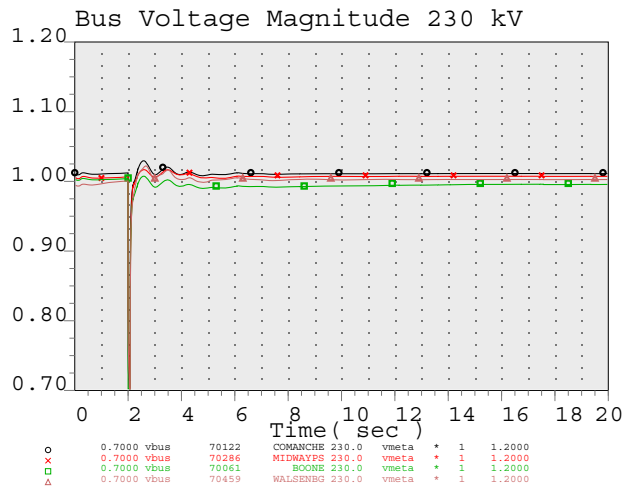

PI-2021-1  
200MW at Comanche 230kV



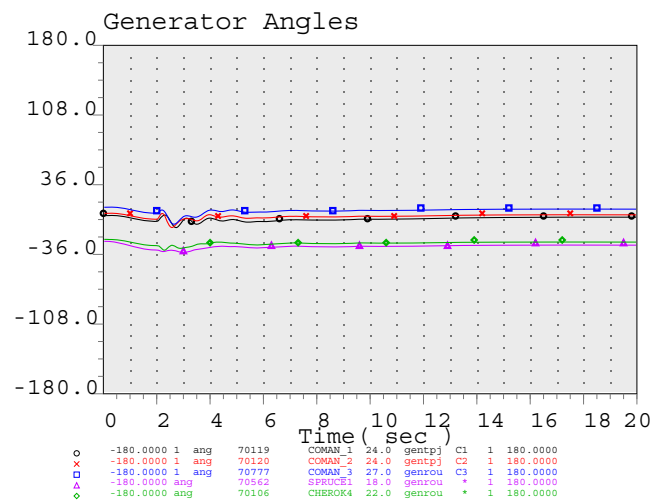
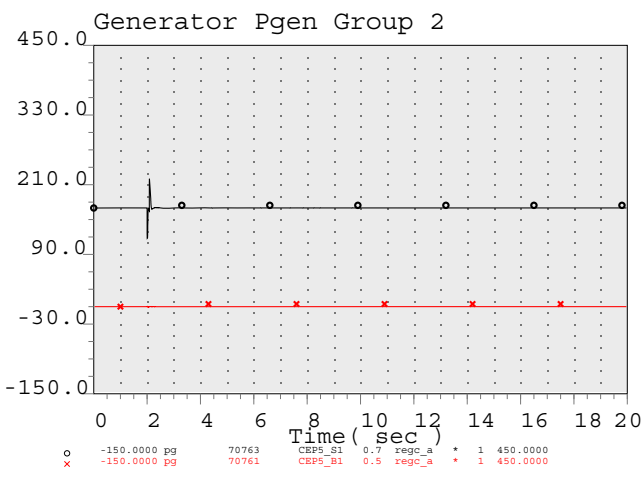
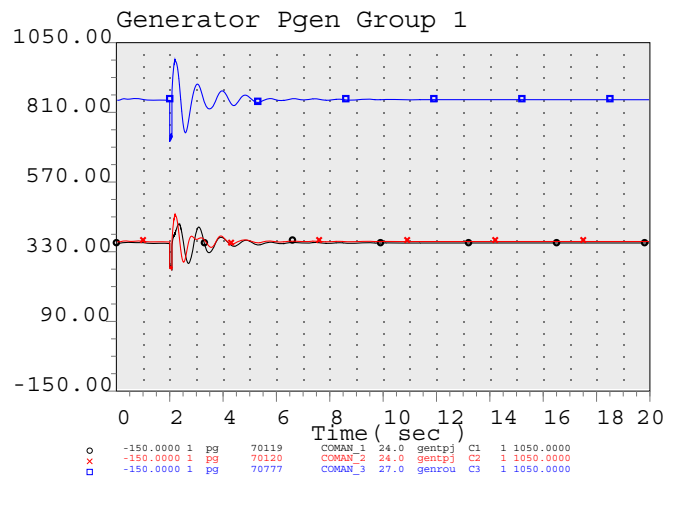
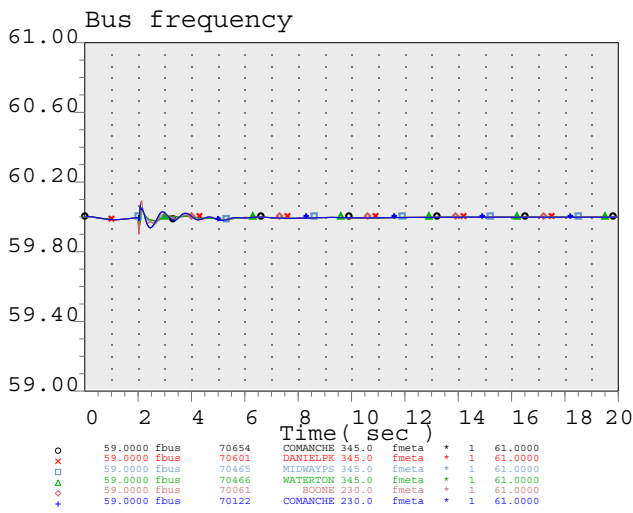
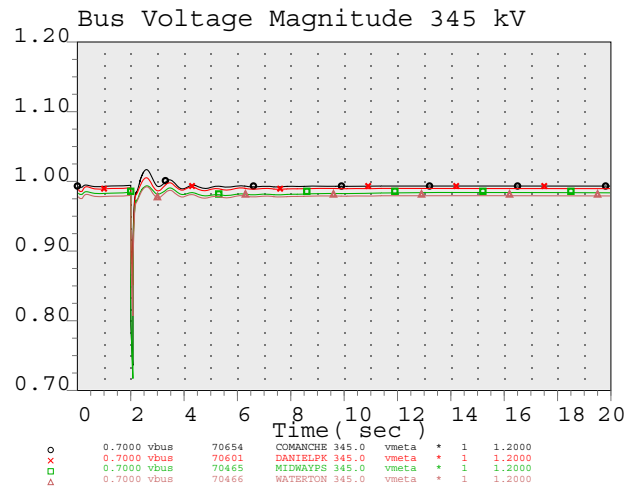
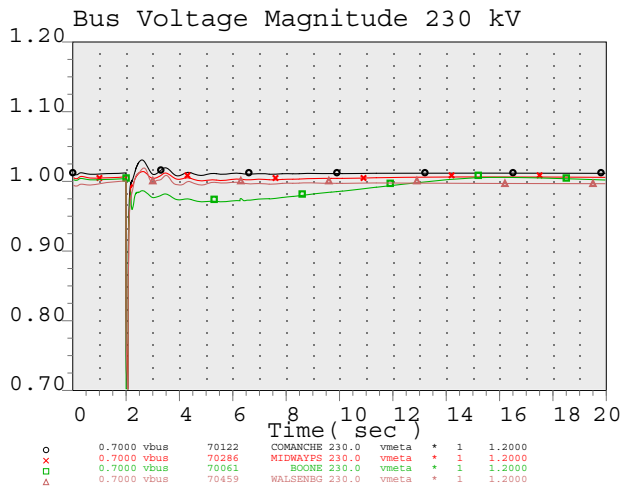

PI-2021-1  
200MW at Comanche 230kV



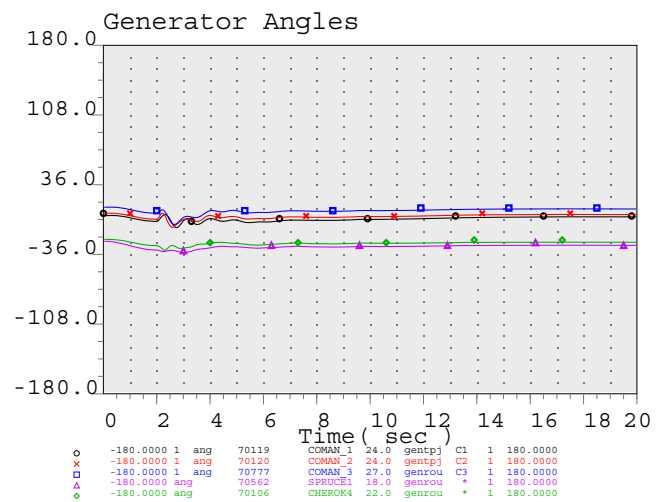
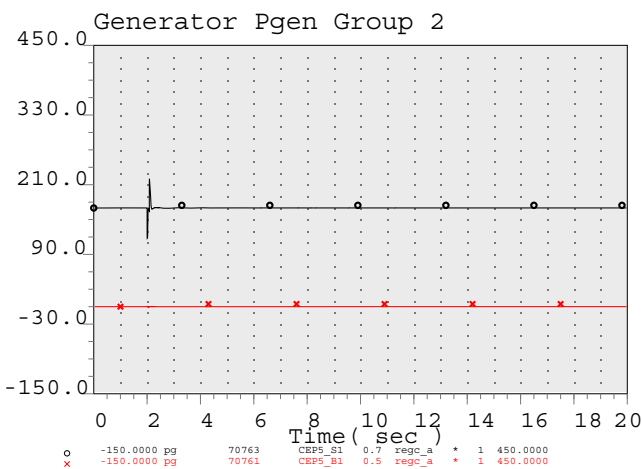
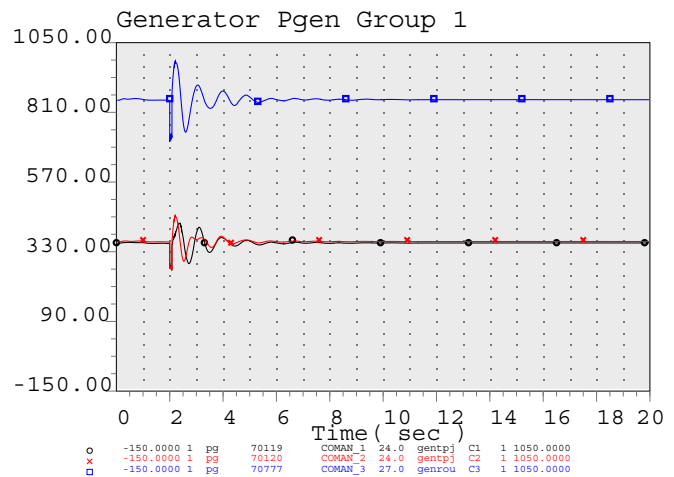
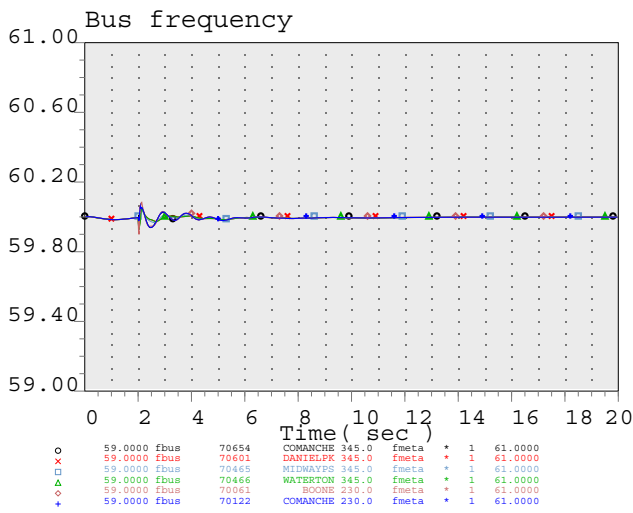
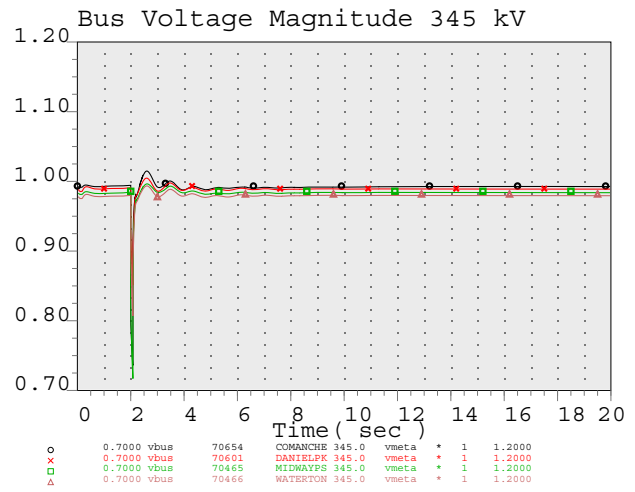
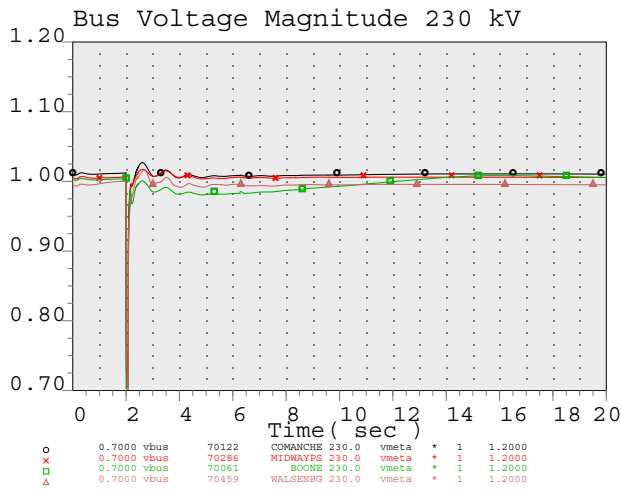

PI-2021-1  
200MW at Comanche 230kV



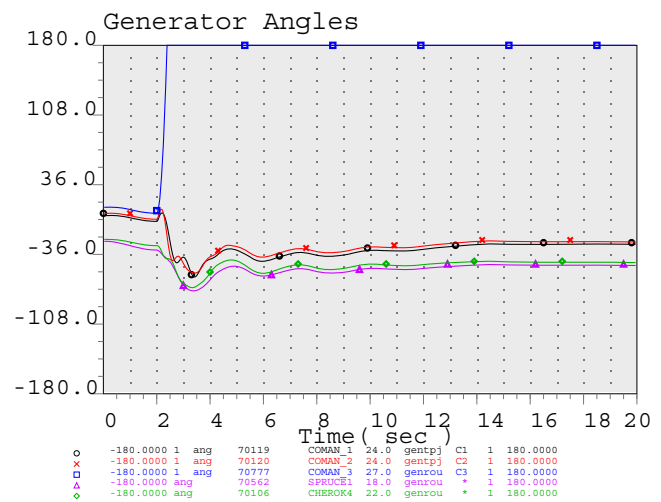
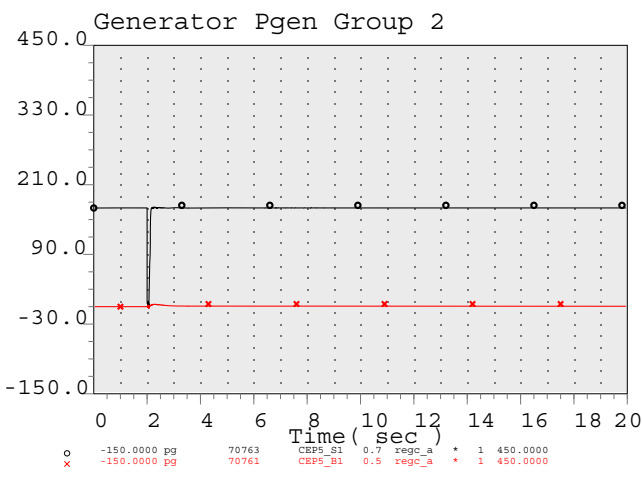
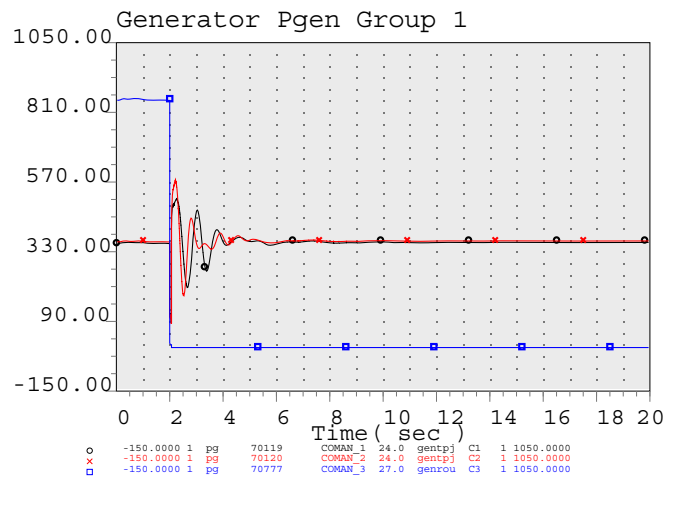
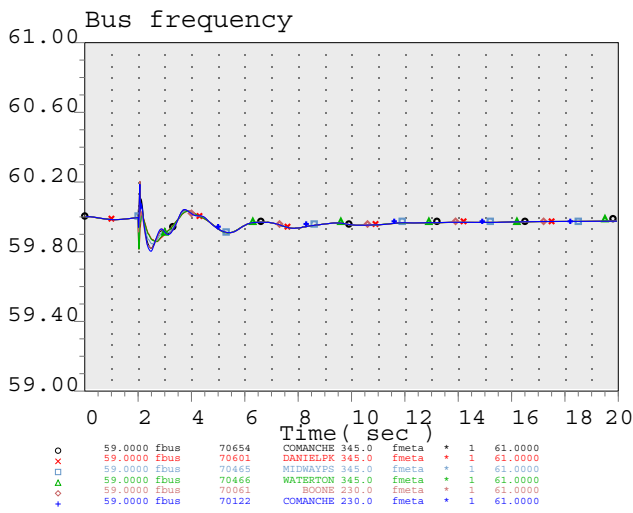
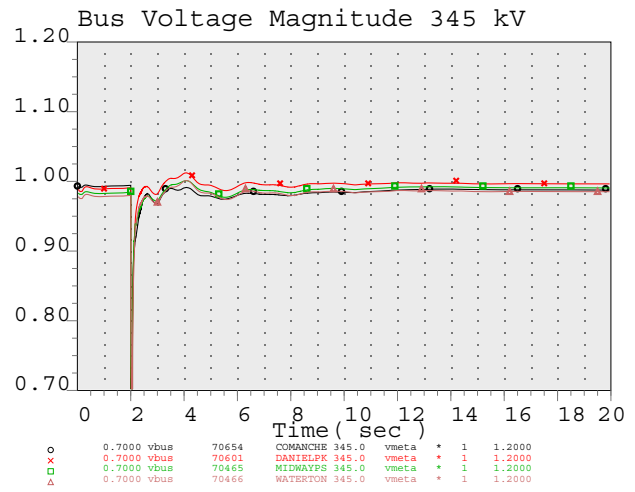
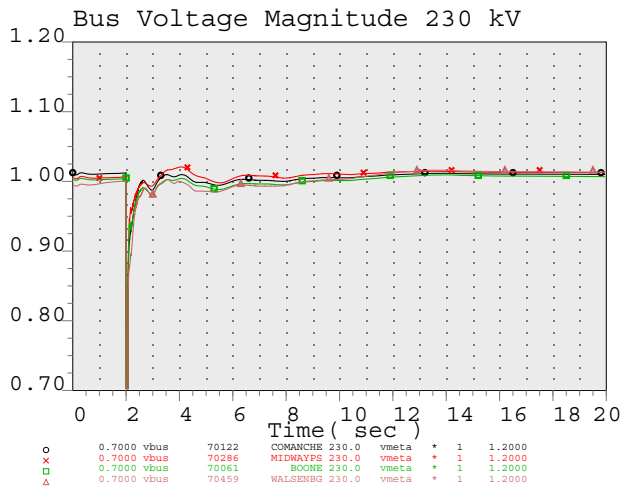

PI-2021-1  
200MW at Comanche 230kV



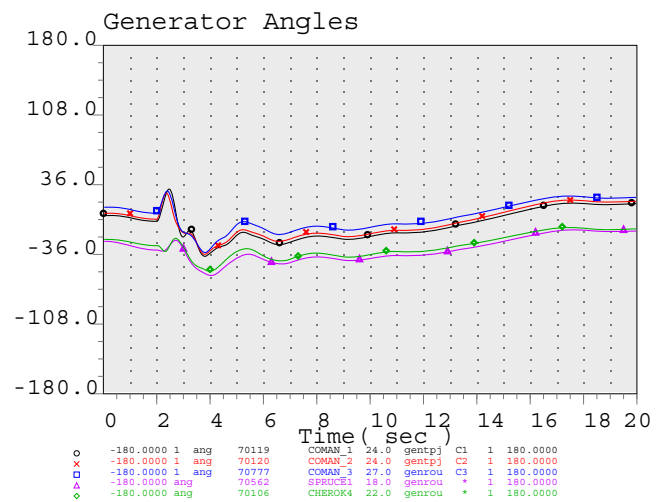
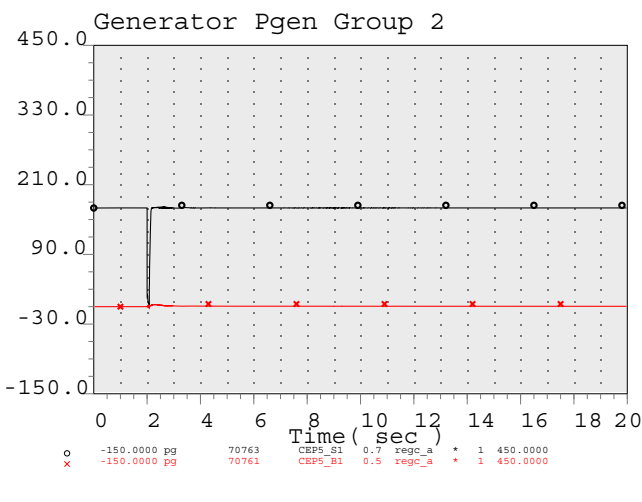
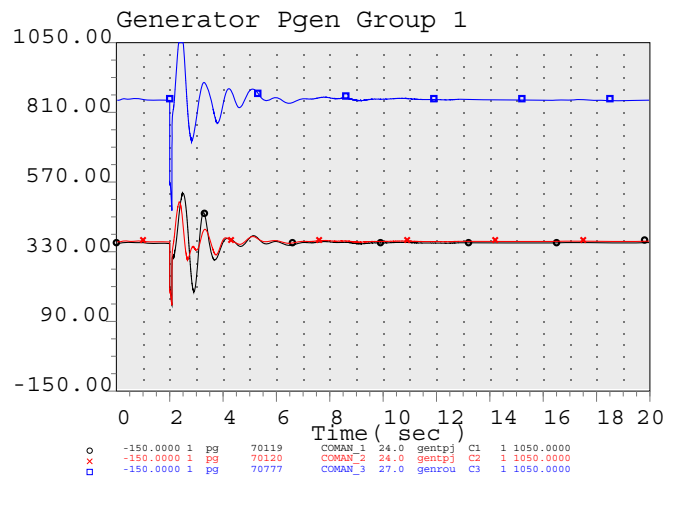
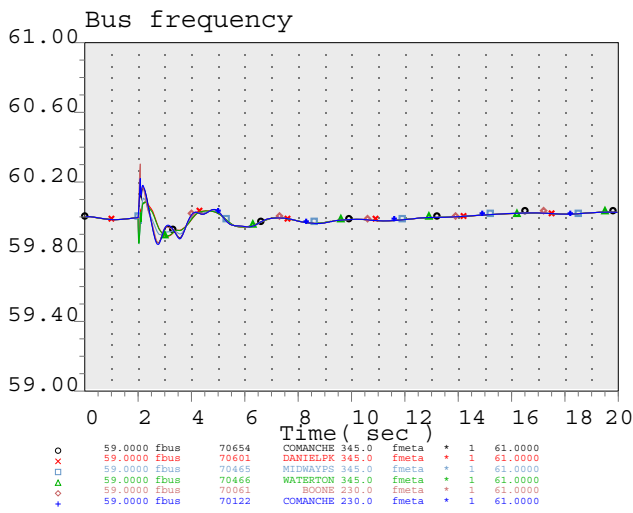
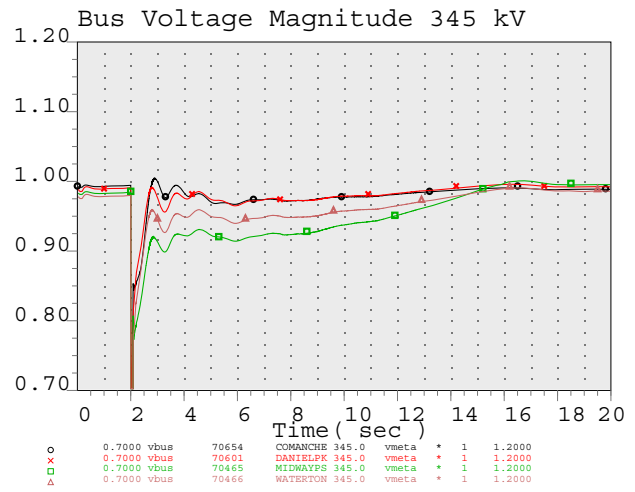
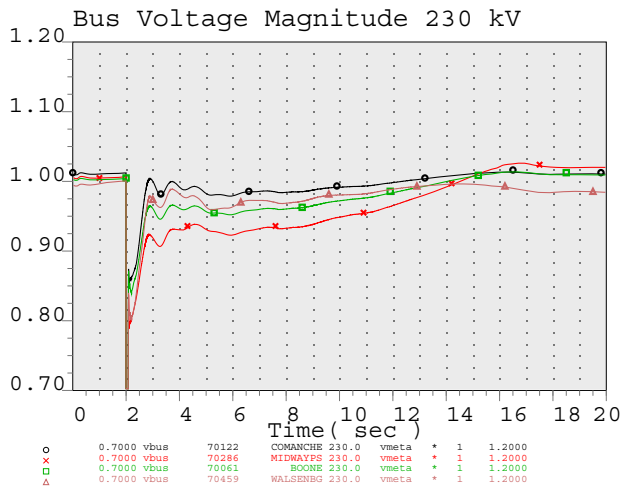

PI-2021-1  
200MW at Comanche 230kV





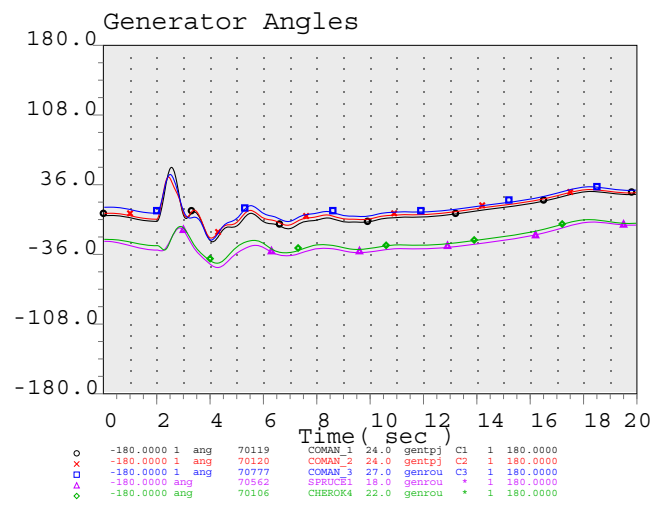
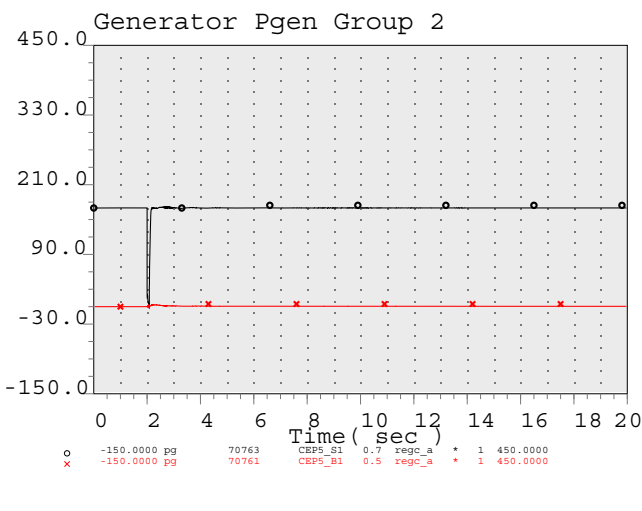
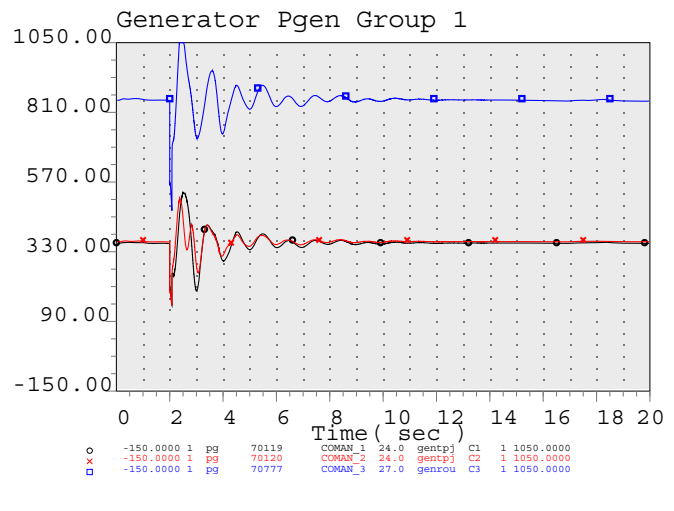
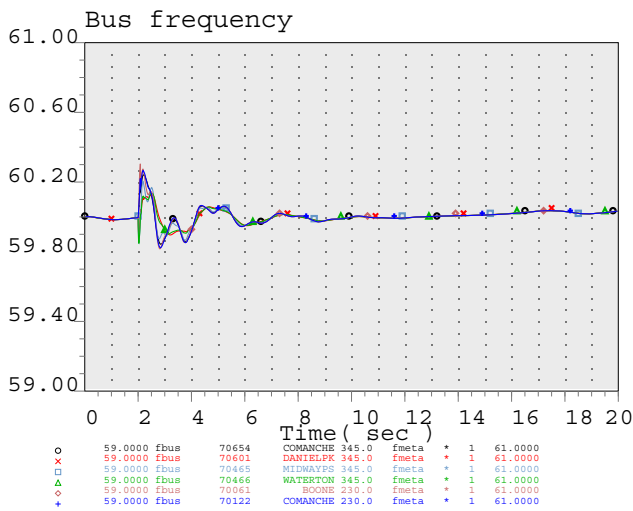
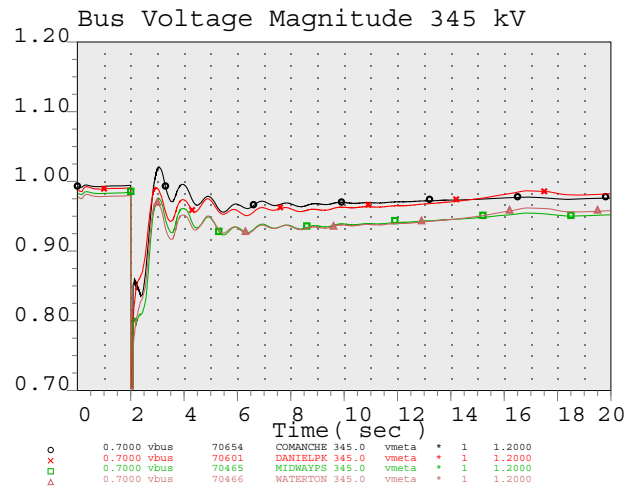
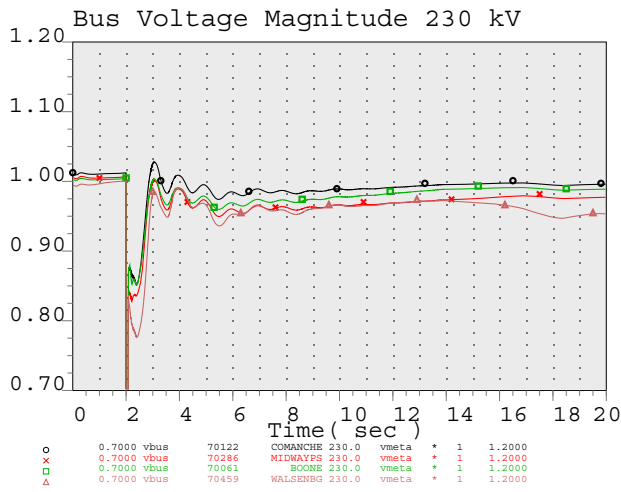

PI-2021-1  
200MW at Comanche 230kV



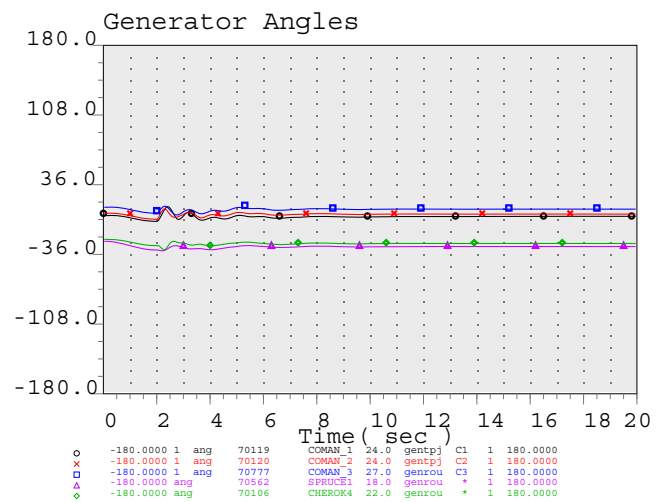
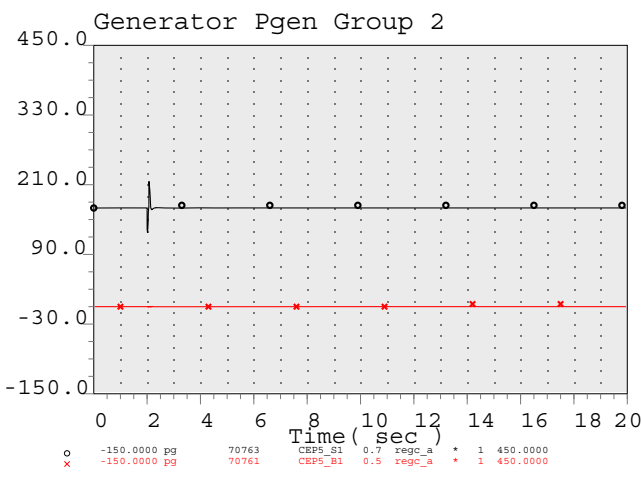
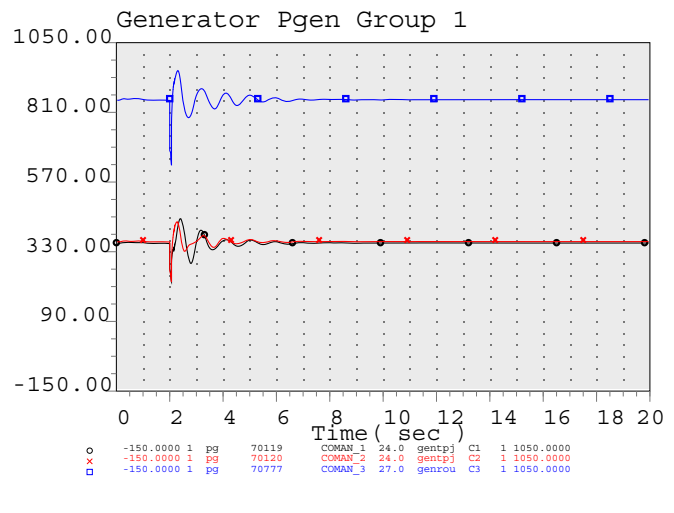
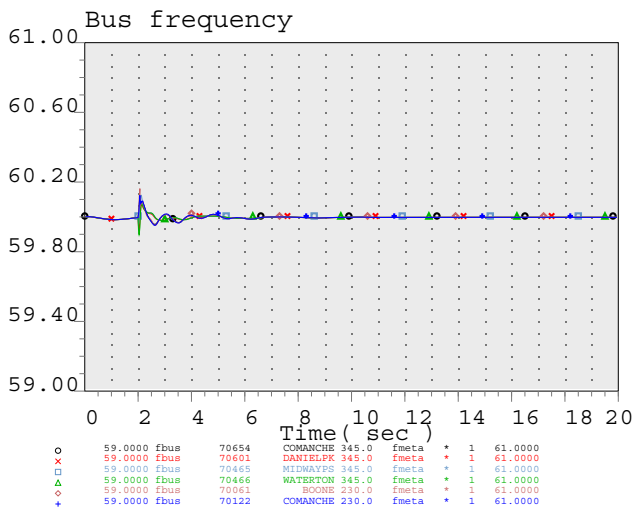
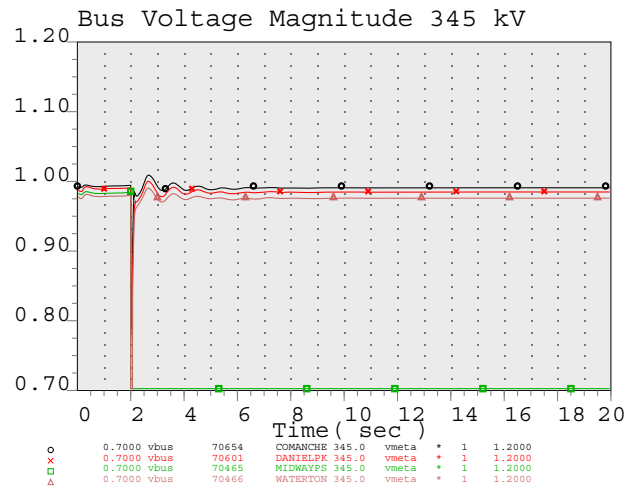
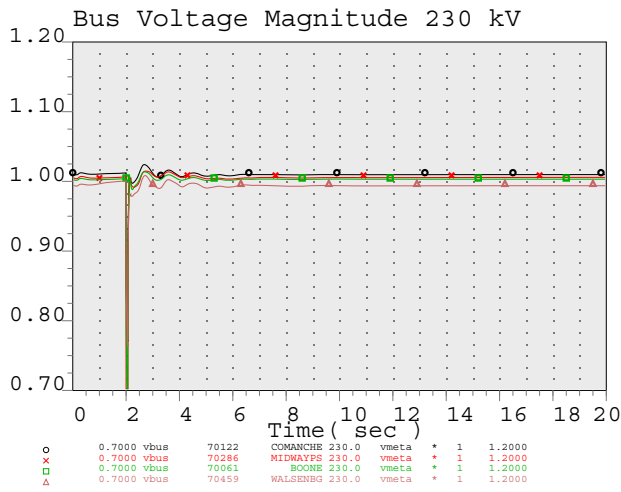

PI-2021-1  
200MW at Comanche 230kV

